

Stückliste AvantGarde

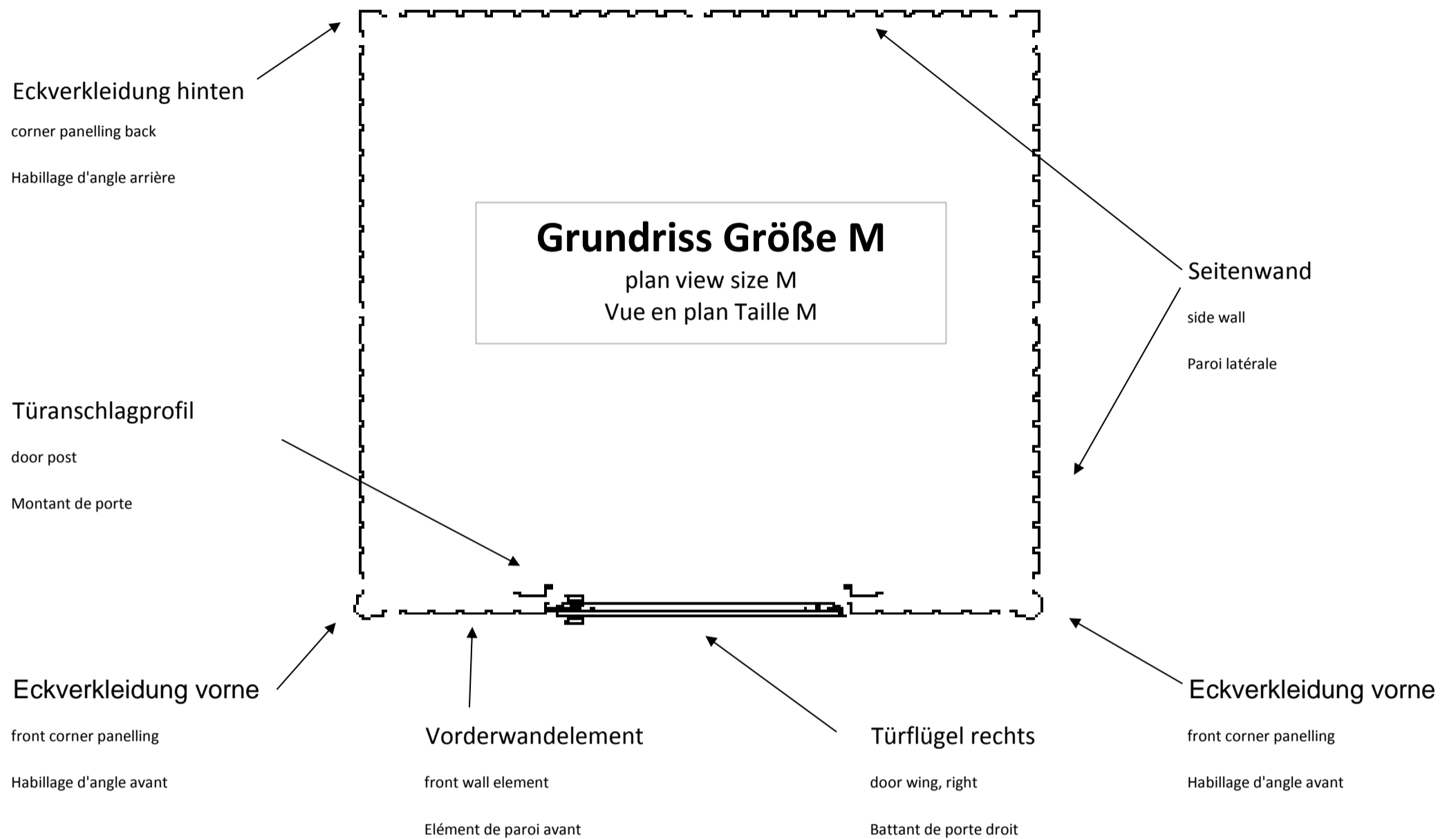

		AvantGarde M		AvantGarde L		DE	GB	FR	
Pos.-Nr. position	Art.-Nr. item numb. No. Ref.	Stück piece pièce	Maße/mm dimens./mm mesure/mm	Stück piece pièce	Maße/mm dimens./mm mesure/mm	Benennung	description	désignation	
Paket 1 (Standardtür) package 1 (standard door) paquet 1 (porte standart)	A	XH*00101	2	1880	2	1880	Vorderwandelement	front wall element	élément de paroi avant
	B	X3*00220	1	1855	1	1855	Tür rechts komplett	right door complete	battant de porte droit riveté
	E	X3*00430	2	516	2	516	Werkzeughalter	tool holder for door	support d'outils pour porte
	F	XH701106	1	798	1	798	Türbodenschwelle	door sill	seuil de porte
	G	X3*00100	1	1880	1	1880	Seitenwandelement	side wall	élément de paroi latérale
	H	X3001224	1	/	1	/	Gasdruckfeder 75N	gas assisted damper	ressort à gaz
	J	X3000227	1	/	1	/	Gasfederkonsole für Tür	damper bracket for door	console de ressort à gaz pour porte
	K	XH700250	1	/	1	/	Drehknopf innen mit Rosette	internal rotary knob with rosette	serrure à griffes avec rosette
	T	X3000226	1	/	1	/	Gasfeder-Konsole Kopfprofil	damper bracket for top profile	console de ressort à gaz pour profil de tête
	D4	X3000557	1	/	1	/	Schraubenpaket Standardtür	screw packet standard door	paquet de vis pour porte std.
Paket 1 (Doppeltür) package 1 (double door) paquet 1 (porte double)	A	XH*00101			2	1880	Vorderwandelement	front wall element	élément de paroi avant
	B	X3*00220			1	1855	Tür rechts komplett	right door wing	battant de porte droit riveté
	E	X3*00430			2	516	Werkzeughalter	tool holder for door	support d'outils pour porte
	F	XH702106			1	1596	Türbodenschwelle	door sill	seuil de porte
	H	X3001224			2	333	Gasdruckfeder 75N	gas assisted damper	ressort à gaz
	I	XH700248			2	255	Abdeckblech für Türanschlagprofil		
	J	X3000227			2	/	Gasfederkonsole für Tür	damper bracket for door	console de ressort à gaz pour porte
	K	XH700250			2	/	Drehknopf innen mit Rosette	internal rotary knob with rosette	serrure à griffes avec rosette
	T	X3000226			2	/	Gasfeder-Konsole Kopfprofil	damper bracket for top profile	console de ressort à gaz pour profil de tête
	ZA	X3*00240			1	1855	Türflügel links komplett	left door wing complete	battant de porte gauche
D4	X3000549			1	/	Kleinteilepäckchen Doppeltür	small parts package double door	paquet de petits éléments pour double porte	
Paket Nr.2 Seitenwandpaket side wall paroi latérale	G	X3*00100	5	1880	7	1880	Seitenwandelement	side wall	élément de paroi latérale
Paket Nr.3 Profilpaket package 3 profile package paquet 3 paquet profiles	L	X3002104	4	1710	2	1710	Bodenprofil	bottom section	profil de sol
	L	X3003104			2	2510	Bodenprofil	bottom section	profil de sol
	M	XH700111	2	1880	2	1880	Türanschlagprofil	door post	montant de porte
	O	X3002107	2	1710	2	1710	Kopfprofil links/rechts	top section left/right	profil de tête gauche / droit
	P	X3002110	1	1730			Kopfprofil hinten	top section back	profil de tête arrière
	P	X3003110			1	2530	Kopfprofil hinten	top section back	profil de tête arrière
	R	X3000400	2	/	2	/	Regalsteher	shelf support, vertical	montant d'étagère
	S	X3002309	1	1730			Dachträger	roof support beam	porte-toit
	S	X3003309			1	2530	Dachträger	roof support beam	porte-toit
	U	X3000451	1	/	1	/	Moosgummi	foam rubber	caoutchouc-mousse
	V	X3000112	1	/	1	/	Gummiprofil	rubber profile	profil gommeux
	AI	X4000425	4	/	4	/	Gerätehalter	equipment holder	support d'outils
	D1	X3000550	1	/	1	/	Kleinteilepäckchen	small parts package	paquet de petites pièces
	D2	X3000552	1	/			Schraubenpaket	screw packet	paquet de vis
D2	X3000553			1	/	Schraubenpaket	screw packet	paquet de vis	
Paket Nr. 4 Dachpaket package 4 roof panel package paquet 4 tôles de toit	W	X3*02301	1	2150	1	2150	Dachblech links	roof panel, left	Tôle du toit gauche
	X	X3*02300	2	2150	4	2150	Dachblech	roof panel	tôle du toit
	Y	X3*02302	1	2150	1	2150	Dachblech rechts	roof panel, right	tôle du toit droite
	Z	X3*02303	1	1800			Dachrinne	gutter unit	gouttière
	Z	X3*03303			1	2600	Dachrinne	gutter unit	gouttière
	AA	X3*02305	1	1800			Dachblecheinfassung	roof panel border	bordure de tôle du toit
	AA	X3*03305			1	2600	Dachblecheinfassung	roof panel border	bordure de tôle du toit
	AB	X3*02310	1	1730			Acrylglaseinfassung		
	AB	X3*03310			1	2530	Acrylglaseinfassung		
	AC	XH*00102	2	2217	2	2217	Eckverkleidung vorne	corner panelling, front	revêtement d'angle avant droit
	AD	X3*00105	2	1880	2	1880	Eckverkleidung hinten	corner panelling, back	revêtement d'angle arrière
	AE	X3*02108	1	1710			Alu-Kopfprofil vorne	aluminium top profile, front	profil de tête aluminium avant
	AE	X3*03108			1	2510	Alu-Kopfprofil vorne	aluminium top profile, front	profil de tête aluminium avant
	AF	X3*02109	2	1680	2	1680	Abdeckleiste für Kopfprofil	cover strip for top profile	couvre-joint pour profil de tête
	AH	X3002312	1	1730			Acrylglas	perspex glas	Verre acrylique
	AH	X3003312			1	2530	Acrylglas	perspex glas	Verre acrylique
	AK	X4000408	1	740	1	740	Regalboden schmal	shelf unit	étagère
	AK	X4000409	1	740	1	740	Regalboden breit	shelf unit	étagère
	AL	X3*02313	1	1721	1	1721	Giebelblech links	gable plate, left	tôle de pignon gauche
	AM	X3*02314	1	1721	1	1721	Giebelblech rechts	gable plate, right	tôle de pignon droite
	AO	X3*02308			2	230	Verbindung Kopfprofil-Dachblech	support for top profile-roof support	liaison profil de tête / tôle du toit
	AP	X3400460	1		1		Ausbesserungslackstift dunkelgrau-met.	touching up paint pen metallic dark grey	laque de réparation gris foncé
X4300460		Ausbesserungslackstift silber-met.					touching up paint pen metallic silver	laque de réparation argent mét.	
X4200460		Ausbesserungslackstift dunkelgrün					touching up paint pen dark green	laque de réparation vert foncé	

	Anmerkung zu Artikelnummern	NOTE concerning art.no.:	REMARQUE concernant N° article:
* → 4	dunkelgrau-metallic	metallic dark grey	gris foncé mét
* → 3	silber-metallic	silvermetallic	argent métallique
* → 2	dunkelgrün	dark green	vert foncé

Paket Nr.1

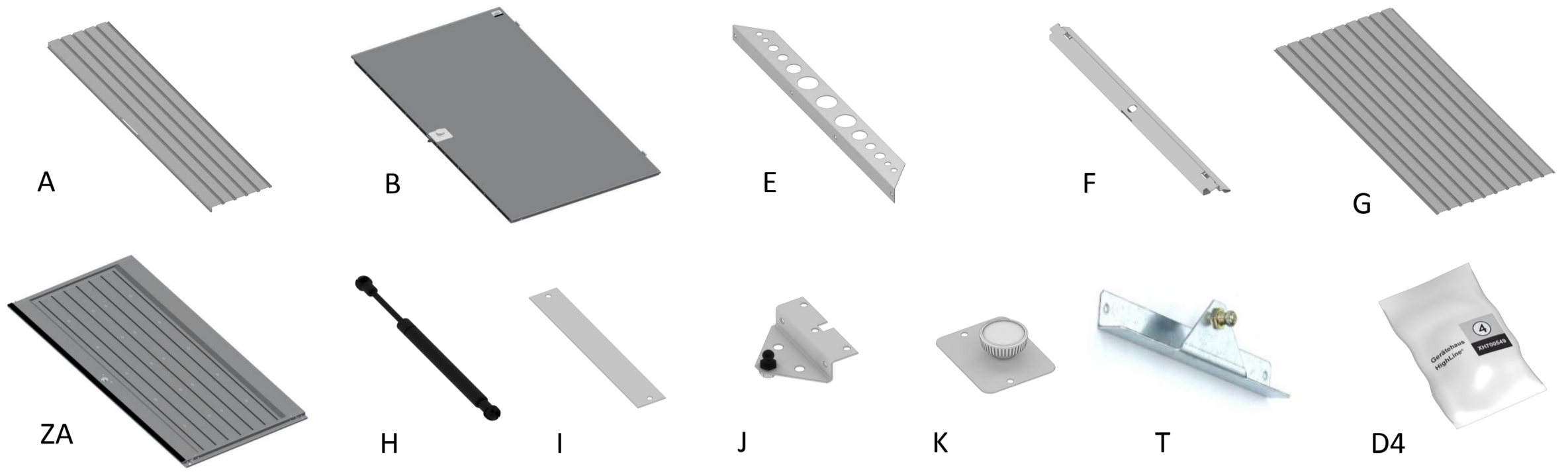

Paket Nr.2

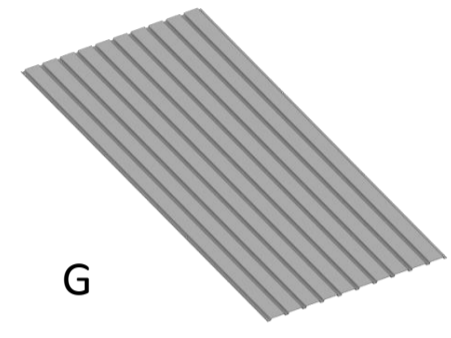



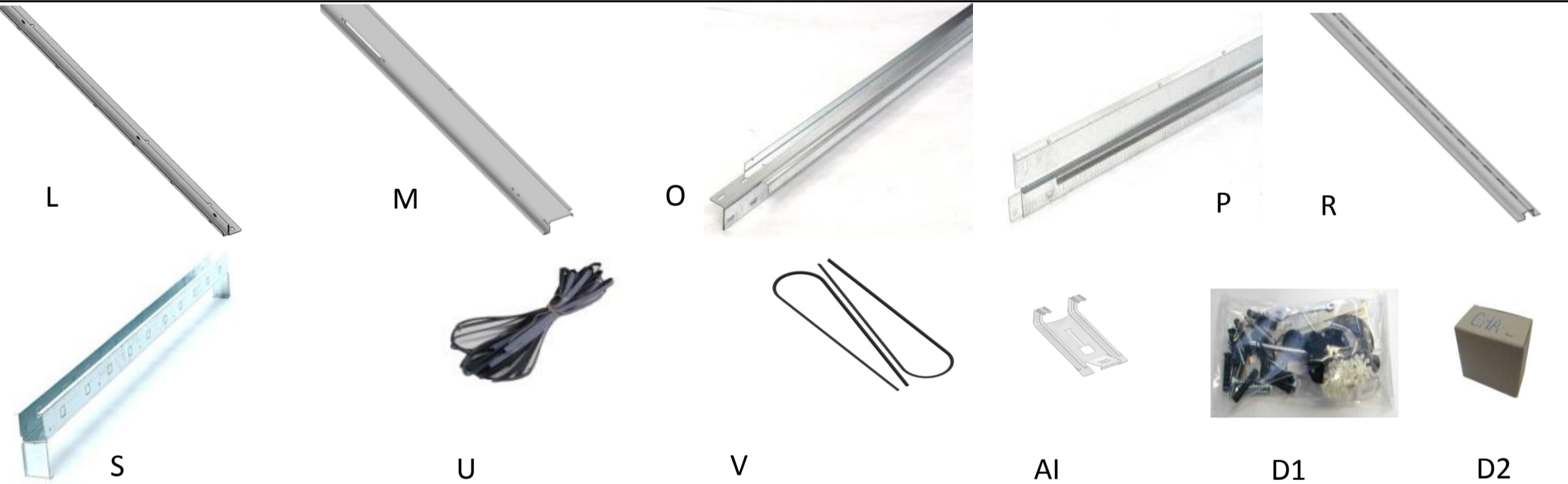



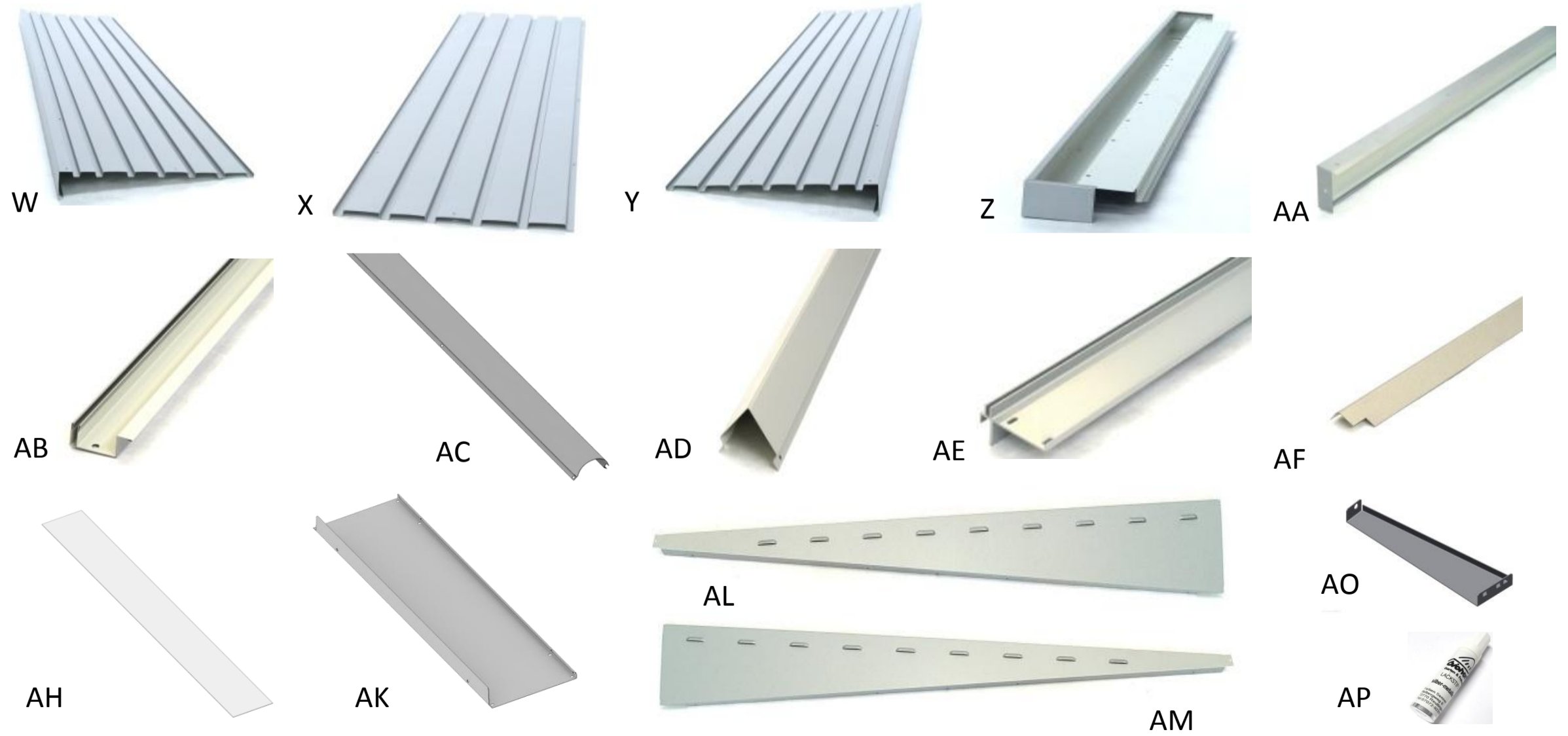









Paket Nr.3



Paket Nr.4



	Art.-Nr. item numb. No. Ref.	Stück piece pièce	Maße/mm dimens./mm mesure/mm	Benennung description désignation	
D1 Kleinteilepäckchen small parts packet paquet de petites pièces X3000550	X2000065	1		Steckschlüssel SW8 mit blauen Griff socket wrench SW 8 tournevis à embout spécial SW 8	
	X2000064	1		Gabelschlüssel SW8,SW10 flat spanner SW 8 / SW10 clé plate SW 8 / SW10	
	X4000401	4	215 x 70	Regalkonsole shelf bracket support d' étagère	
	A52076	8	ø8 x 60	Sechskant Holzschraube 8x60mm hexagonal head wood screw vis hexagonale pour bois	
	A55007	8	ø8,4 x 16	Beilagescheibe washer rondelle	
	A51050	8	ø10	Dübel F10 schwarz dowel F10 cheville	
	A51044	4	ø4,8 x 9,5	Blechschrabe mit Kreuzschlitz self-tapping screw, philips head vis à tôle	
	X3000201	1	65 x 34	Edelstahlscharnier "A" stainless steel hinge "A" charnière "A"	
	X3000202	1	65 x 34	Edelstahlscharnier "B" stainless steel hinge "B" charnière "B"	
	X4000416	1	ø31,5 x 15	Dachrinnenstopfen gutter plug bouchon obturateur	
	X4000417	1	ø31,5 x 26	Dachrinnenauslauf gutter outlet bouchon d'évacuation des eaux	
	X4000415	1	ø27 x 4	Sicherungsring safety ring bague de sécurité	
	X4000414	1	M30 x 1,5	Sechskantmutter hex-nut écrou hexagonal	
	X3000615	2	73 x 73	Abdeckung für Eckverkleidung floor seal or corner panel couverture pour le revêtement cornier	
	X3000419	120	ø6,7 x 8	Abdeckkappen cover caps (white plastic) petite gaine pour vis saillante	
	X2000040	1		Handschuh	
Y1000006	1		Schlüsselanhänger key ring Déjà traduite		
A52012	1	ø5 x 140	Drahtstift 5x140mm nail clou de montage		

	Art.-Nr. item numb. No. Ref.	Stück piece pièce	Maße/mm dimens./mm mesure/mm	Stück piece pièce	Maße/mm dimens./mm mesure/mm	Benennung description désignation	
D2 Schraubenpaket screw-packet paquet de vis X3000552 (M) X3000553 (L)	A52002	120	M5 x 10	145	M5 x 10	Flachrundschrabe mushroom head screw vis ronde à tête plate	
	A2000033	120	M5	145	M5	Mutter Niro M5 nut, stainless steel M5 écrou hexagonal	
	A2000025	140	ø5,3 x 10	170	ø5,3 x 10	Beilagscheibe washer rondelle	
	A4002017	20	ø4,8 x 13	24	ø4,8 x 13	Sechskant-Blechschrabe self-tapping screw vis hexagonale p. tôle	
D4 Schraubenpaket screw-packet paquet de vis X3000557 (Standard-Tür)	X3000244	1	235 x 30	1	235 x 30	Schließblech für Tür rechts	
	XH700248	1	255 x 32	1	255 x 32	Abdeckblech für Türanschlagprofil	
	A4003026	2	M5 x 12	2	M5 x 12	Senkschrabe mit Kreuzschlitz	